

MIKA 4230-8 FOR ARENA 82X0

PROJECT PROJET
SPEC TYPE
NOTES

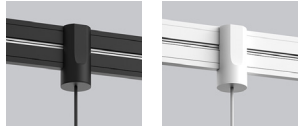

ADAPTER FINISH FINI DE L'ADAPTEUR



BLKE WHE

FAMILY FAMILLE



ARENA - BEAM 8290 ARENA - GLOW 8291 ARENA - AIM 8292 ARENA - BALL 8295



ARENA - CONE 8294 ARENA - SLICE SQ 8296 ARENA - ACOUSTIC 8298

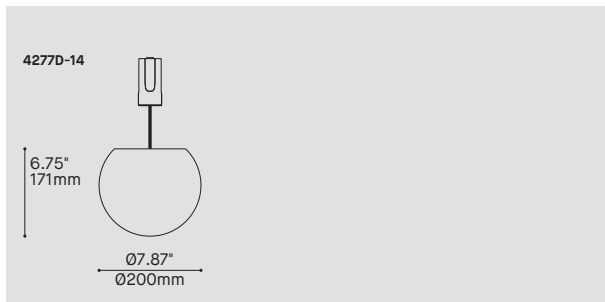

ORDERING SPECIFICATION	SPÉCIFICATION DE COMMANDE	CODE
MODEL MODÈLE		4230-8
4230-8	MIKA 8"	
LIGHT SOURCE SOURCE LUMINEUSE		LEDA
LEDA*	SPECIAL OUTPUT FOR ARENA, 8W * TOTAL DC LOAD OF INSTALLED LIGHT SOURCES MUST NOT EXCEED 90W OR 180W DEPENDING ON THE SELECTED OPTION	
COLOR TEMPERATURE TEMPÉRATURE DE COULEUR		
27*	2700K	
30	3000K	
35	3500K	
40	4000K	
*LONGER LEAD TIME MAY APPLY, PLEASE CONTACT YOUR EUREKA REPRESENTATIVE		
COLOR RENDERING INDEX INDICE DE RENDU DE COULEUR (IRC)		
80	80+ CRI	
90*	90+ CRI	
*LONGER LEAD TIME MAY APPLY, PLEASE CONTACT YOUR EUREKA REPRESENTATIVE		
CABLE CÂBLE		C
C	BLACK OR WHITE CABLE, FIELD ADJUSTABLE	
CABLE LENGTH LONGUEUR DE CÂBLE		
24	24" CABLE (STD LENGTH)	
**	CUSTOM CABLE LENGTH (PLEASE SPECIFY)	
MOUNTING MONTAGE		
TAA	ARENA ADAPTOR FOR ARENA SQUARE & RECTANGLE 8220 & ARENA STRAIGHT 8210	
TAB	ARENA ADAPTOR FOR ARENA RING 8200	
ADAPTER FINISH FINI ADAPTEUR		
BLKE	BLACK FINE TEXTURED	
WHE	WHITE FINE TEXTURED	
POWER CORD FINISH FINI ADAPTEUR		
BLK	BLACK POWER CORD	
WH	WHITE POWER CORD	
DIFFUSER FINISH FINI DIFFUSEUR		WH
WH	WHITE	

PRODUCT CHARACTERISTICS CARACTÉRISTIQUES DU PRODUIT



- DESIGN:** Classic round globe with an evenly frosted shade of 8" diameter. Translucent white diffuser made of impact resistant rotomolded MDPE.
- INSTALLATION:** Magnetically positioned anywhere on the ARENA for easy on-site installation or reconfiguration of the lighting environment. The adapter has a hook for extra safety.
- LIGHT SOURCE:** High performance LED module mounted on an extruded aluminum heatsink.
- ADAPTER:** Custom designed aluminum base offered in white or black architectural grade finish.
- CERTIFIED:** c-CSA-us
- CONCEPTION:** Globe rond classique composé d'un diffuseur uniformément givré de 8" de diamètres. Diffuseur blanc translucide en MDPE rotomoulé résistant aux chocs.
- INSTALLATION:** Positionné magnétiquement n'importe où sur l'ARENA pour faciliter l'installation ou la reconfiguration de l'éclairage sur site. L'adaptateur est muni d'un crochet pour une double sécurité.
- SOURCE LUMINEUSE:** Module DEL à haute intensité monté sur un radiateur en aluminium extrudé.
- ADAPTEUR:** Base en aluminium conçu sur mesure offert avec une finition noire ou blanche de grade architectural.
- CERTIFIÉ:** c-CSA-us

ARENA - ADAPTER TAA / TAB

ARENA (8200/8220/8210) REQUIS
(SOLD SEPARATELY)
TAA - for Arena 8210 & 8220
TAB - for Arena 8200

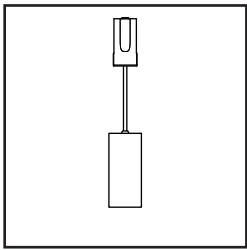
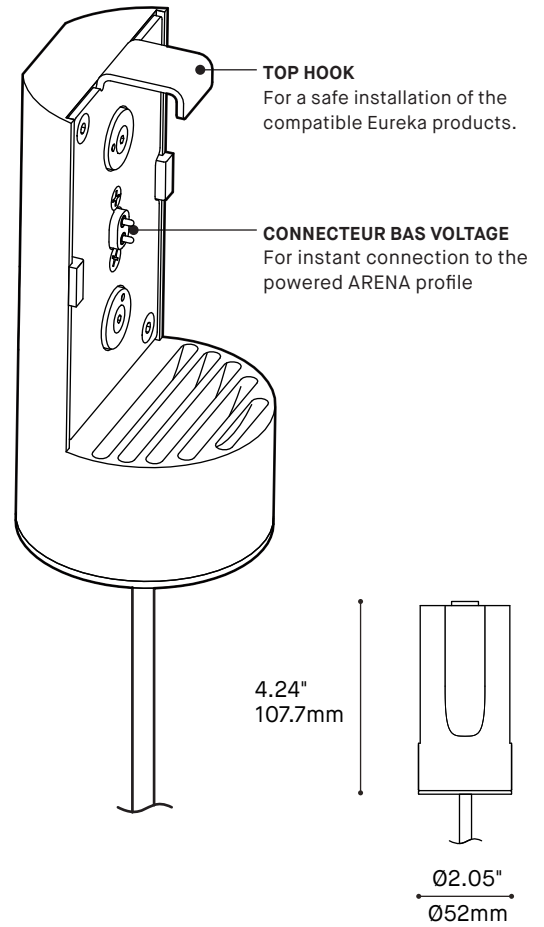
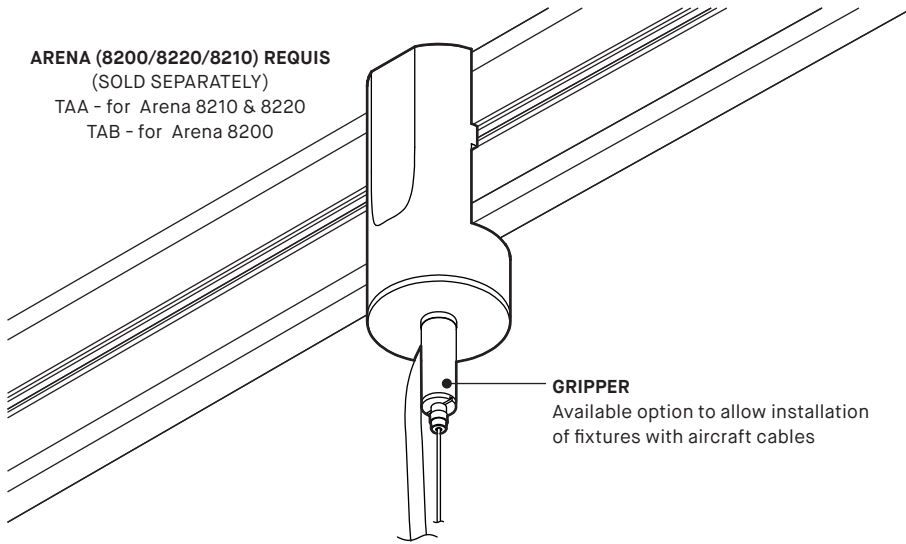

SCOUT

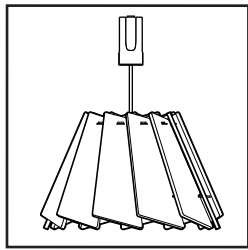

MINI MUTE

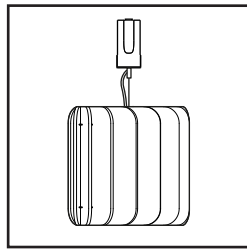

MILL 14"

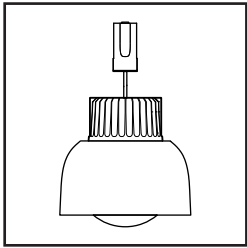

BLOOM

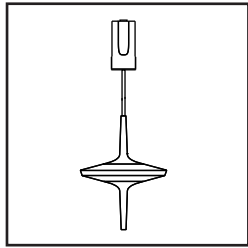

CELESTE

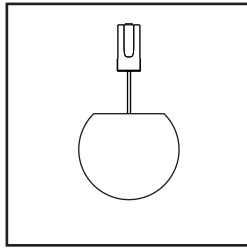

MIKA 8"

EVEN MORE POSSIBILITIES

This adapter allows multiple Eureka luminaires to be magnetically positioned anywhere on all ARENA structures. For easy installation or on-site reconfiguration of the lighting environment. Cable length is not field adjustable and must be specified to desired length.

PRODUCT SPECIFICATIONS

SCOUT 4048/4049-XX MINI MUTE 4258-16 MILL 4277D-14 BLOOM 4269-XX CELESTE 4010-CEL1 MIKA 3230-8

PERFORMANCE						
SYSTEM WATTAGE	8 W DC	11 W DC	8 W DC	8 W DC	4 W DC	8 W DC
DELIVERED LUMENS (4000K)	855 LM	707 LM	593 LM	605 TO 797 LM	145 LM	806 LM
EFFICACY	111 LM/W	64.8 LM/W	77 LM/W	78.5 TO 103.5 LM/W	34 LM/W	104.5 LM/W
OTHER INFORMATION						
WEIGHT	MAX 6.05 LBS / 2.65 KG	5.83 LBS / 2.65 KG	11.3 LBS / 4.9 KG	MAX 9.75 LBS / 4.43KG	2.2 LBS / 1 KG	2.2 LBS / 1 KG
L70 (LUMEN MAINTENANCE)	63,000 HRS	60,000 HRS	63,600 HRS	55,000 HRS	60,000 HRS	55,000 HRS
WELL & LEED STANDARD REQUIREMENTS (SEE SPECIFIC PRODUCT SPEC SHEET)						

EFFICACY MULTIPLIERS

CRI	CCT	FACTOR
80+	4000K	1.00
80+	3500K	0.98
80+	3000K	0.94
80+	2700K	0.91
90+	4000K	0.88
90+	3500K	0.85
90+	3000K	0.81
90+	2700K	0.77

LIGHT DISTRIBUTIONAV

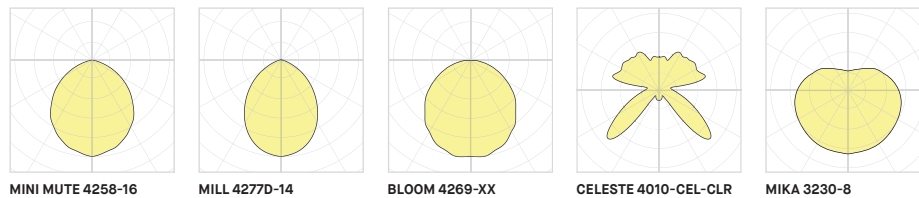

TECHNICAL DATA

ARENA - ADAPTATEUR TAA / TAB

ARENA (8200/8220/8210) REQUIS
(VENDU SÉPARÉMENT)
TAA - pour Arena 8210 & 8220
TAB - pour Arena 8200

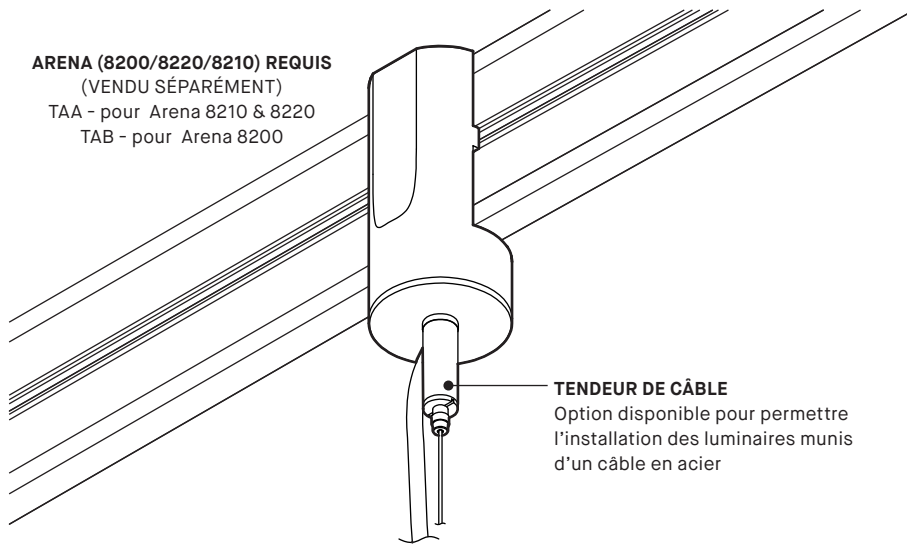

TENDEUR DE CÂBLE
Option disponible pour permettre l'installation des luminaires munis d'un câble en acier

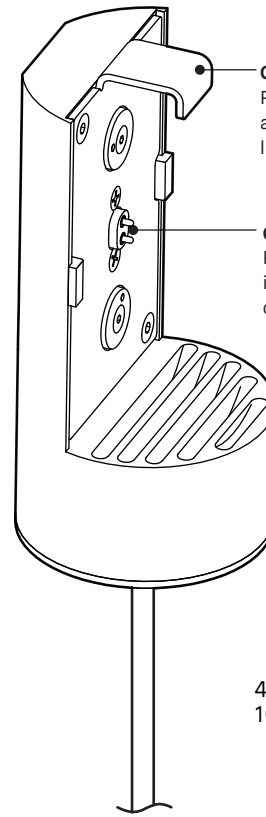

CROCHET SUPÉRIEUR
Pour une installation sécuritaire adaptée au poids des différents luminaires de la gamme Eureka

CONNECTEUR BAS VOLTAGE
Pour une connexion instantanée au profil alimenté du ARENA

4.24"
107.7mm

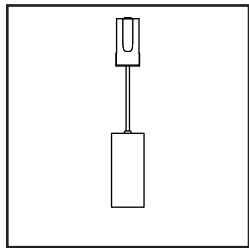
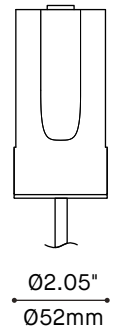

SCOUT

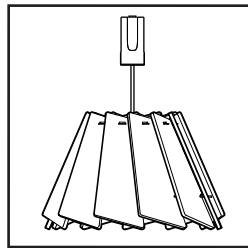

MINI MUTE

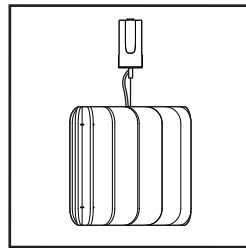

MILL 14"

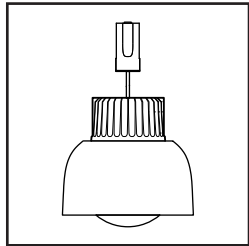

BLOOM

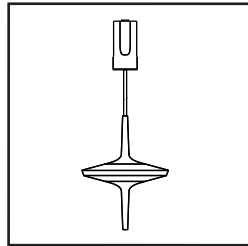

CELESTE

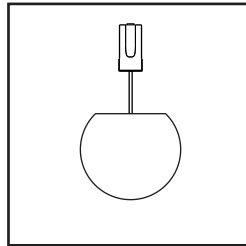

MIKA 8"

ENCORE PLUS DE POSSIBILITÉS

Grâce à cet adaptateur, de nombreux luminaires Eureka peuvent être positionnés magnétiquement n'importe où sur les différentes structures ARENA.

Pour une installation facile ou une reconfiguration de l'éclairage sur site.

La longueur du câble n'est pas ajustable, la longueur souhaitée doit être spécifiée.

SPÉCIFICATION SPRODUIT

SCOUT 4048/4049-XX

MINI MUTE 4258-16

MILL 4277D-14

BLOOM 4269-XX

CELESTE 4010-CEL1

MIKA 3230-8

PERFORMANCE

PERFORMANCE	SCOUT 4048/4049-XX	MINI MUTE 4258-16	MILL 4277D-14	BLOOM 4269-XX	CELESTE 4010-CEL1	MIKA 3230-8
PUISSANCE TOTALE	8 W DC	11 W DC	8 W DC	8 W DC	4 W DC	8 W DC
LUMENS RÉELS (4000K)	855 LM	707 LM	593 LM	605 TO 797 LM	145 LM	806 LM
EFFICACITÉ	111 LM/W	64.8 LM/W	77 LM/W	78.5 TO 103.5 LM/W	34 LM/W	104.5 LM/W

AUTRES INFORMATIONS

AUTRES INFORMATIONS	SCOUT 4048/4049-XX	MINI MUTE 4258-16	MILL 4277D-14	BLOOM 4269-XX	CELESTE 4010-CEL1	MIKA 3230-8
POIDS	MAX 6.05 LBS / 2.65 KG	5.83 LBS / 2.65 KG	11.3 LBS / 4.9 KG	MAX 9.75 LBS / 4.43KG	2.2 LBS / 1 KG	2.2 LBS / 1 KG
L70 (LUMEN MAINTENANCE)	63,000 HRS	60,000 HRS	63,600 HRS	55,000 HRS	60,000 HRS	55,000 HRS

CRITÈRES DE CERTIFICATION WELL & LEED (VOIR FICHE TECHNIQUE DU PRODUIT)

FACTEUR D'EFFICACITÉ

IRC	CCT	FACTEUR
80+	4000K	1.00
80+	3500K	0.98
80+	3000K	0.94
80+	2700K	0.91
90+	4000K	0.88
90+	3500K	0.85
90+	3000K	0.81
90+	2700K	0.77

DISTRIBUTION LUMINEUSE

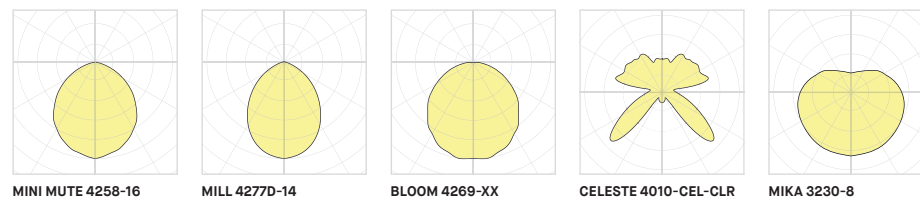

MINI MUTE 4258-16

MILL 4277D-14

BLOOM 4269-XX

CELESTE 4010-CEL-CLR

MIKA 3230-8



Visitez notre site Web pour les termes et conditions.



DONNÉES TECHNIQUES

Arena Mapping







MIXING LIGHT SOURCES IS POSSIBLE AND RECOMMENDED. TO HELP YOU DO SO, SUBSTRACT THE DC LOAD OF EACH LIGHT SOURCE FROM THE MAXIMUM DC LOAD OF ARENA. DO NOT EXCEED MAXIMUM WEIGHT PER SIDE

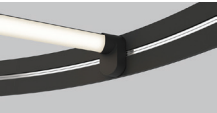
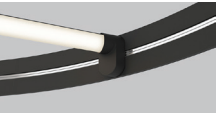
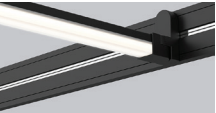
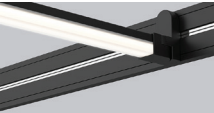

LUMINAIRE	FRAME CONFIGURATION *REFER TO 2D DRAWINGS FOR EACH SIZE.	ARENA RING 8200-36 8200-54	ARENA SQUARE & RECTANGLE			
			8220-36X36 8220-36X54	8220-54X54 8220-36X96 8220-54X96 8220-96X96	8220-36X190 8220-54X190 8220-96X190 8220-190X190	8220-36X380 8220-54X380 8220-96X380 8220-190X380 8220-380X380
	MAXIMUM TOTAL DC LOAD OF ACCESSORY	90W DC	90W DC	180W (90W DC PER 2 SIDES)	360W (90W DC PER SIDES)	540W, 720W (90W DC PER SECTION)
	MAXIMUM TOTAL WEIGHT OF ACCESSORY	25 LBS	25 LBS / SIDE	25 LBS / SIDE	25 LBS / SECTION	25 LBS / SECTION

LUMINAIRE	FRAME CONFIGURATION *REFER TO 2D DRAWINGS FOR EACH SIZE.	ARENA STRAIGHT			
		8210-36 (1 SECTION) 8210-54 (1 SECTION) 8210-70 (2 SECTIONS)	8210-96 (1 SECTION) 8210-158 (3 SECTIONS) 8210-190 (2 SECTIONS)	8210-284 (3 SECTIONS) 8210-380 (4 SECTIONS)	
		MAXIMUM TOTAL DC LOAD OF ACCESSORY	90W (90W DC FOR BOTH SIDES)	180W (90W DC PER SECTION)	360W DC (90W DC PER SECTION)
	MAXIMUM TOTAL WEIGHT OF ACCESSORY	25 LBS / SECTION	25 LBS / SECTION	25 LBS / SECTION	

ACCESSORIES HEAD	LIGHT SOURCES	BEAM 8290	GLOW 8291	AIM 8292	CONE 8294	BALL 8295
						
	DC LOAD	8W DC	8W DC	8W DC	11W DC	8W DC
	WEIGHT LBS	0.62 LBS	0.70 LBS	0.61 LBS	0.88 LBS	0.48 LBS

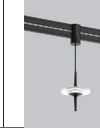
ACCESSORIES SLICE	LIGHT SOURCES	SLICE-ROUND 8293 (ONLY FOR 8200)		SLICE-SQUARE 8296	
		8293-36	8293-54	8296-36	8296-54
					
	DC LOAD	8W DC	11W DC	8W DC	11W DC
WEIGHT LBS	1.24 LBS	1.65 LBS	2.22 LBS	3.50 LBS	

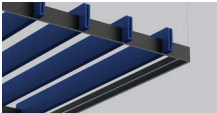
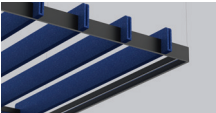
ACCESSORIES ADAPTER	LIGHT SOURCES	MILL 14" 4277D-14	SCOUT 02.75" 4048-XX	SCOUT 04" 4049-XX	MIKA 8" 4230-8	BLOOM 4269-XX	MINI MUTE 4258-16	CELESTE 4010-CEL1
								
	DC LOAD	8W DC	8W DC	8W DC	8W DC	8W DC	11W DC	4W DC
	WEIGHT LBS	11.3 LBS	MAX 4.32 LBS	MAX 6.05 LBS	2.40 LBS	MAX 9.75 LBS	5.83 LBS	2.20 LBS

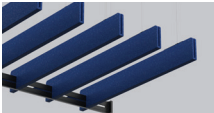
ACCESSORIES ACOUSTIC	ACOUSTIC CONFIGURATION	ACOUSTIC BAFFLE FOR ARENA SQUARE		ACOUSTIC BAFFLE FOR ARENA STRAIGHT	
		8297-40	8297-58	8298-40	8298-58
					
	WEIGHT LBS	1.38 LBS / PANEL	1.63 LBS / PANEL	1.38 LBS / PANEL	1.63 LBS / PANEL
CONFIGURATION USE FOR ARENA	8220-36X36 8220-36X54 8220-36X96	8220-54X54 8220-36X54 8220-54X96	8210-XX 8220-XX	8210-XX 8220-XX	

*WE RESERVE THE RIGHT TO MODIFY ANY INFORMATION AT ANY TIME.

ARENA 8200

PROJECT PROJÉT
SPEC TYPE
NOTES

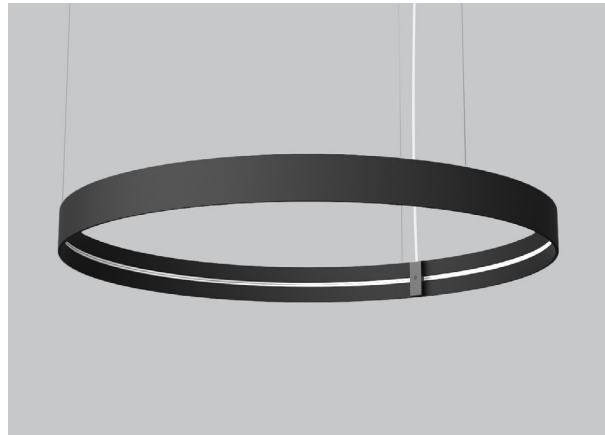

FAMILY FAMILLE

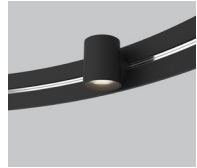

ARENA - BEAM 8290



ARENA - GLOW 8291

FINISH FINI



BLKE



ARENA - SLICE 8293



ARENA - AIM 8292



WHE

MOUNTING OPTIONS OPTIONS DE MONTAGE

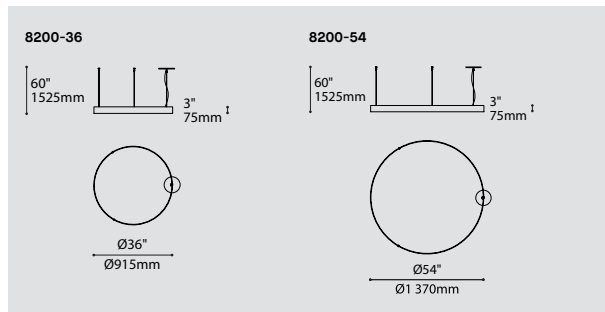
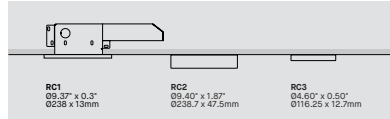

ORDERING SPECIFICATION SPÉCIFICATION DE COMMANDE

CODE

MODEL MODÈLE

8200-36 ARENA 36"
 8200-54 ARENA 54"

MAXIMUM DC LOAD PUISSANCE MAXIMALE DC

90W 90 WATT DC

90W

TOTAL DC LOAD OF INSTALLED LIGHT SOURCES MUST NOT EXCEED 90W. (see mapping page)

RING
ARENA 8200-36 & 8200-54
MAXIMUM DC LOAD 90W

LIGHT SOURCES				
BEAM 8290	GLOW 8291	AIM 8292	SLICE RD 8293-36	SLICE RD 8293-54
8W DC	8W DC	8W DC	8W DC	11W DC

VOLTAGE VOLTAGE

120V 120 VOLT
 277V 277 VOLT

CONTROL OPTION OPTION DE CONTRÔLE

DV 0-10V DIMMING (120V-277V)
 NLTAIR2* NLIGHT AIR CONTROL GEN 2 (NOT AVAILABLE WITH MOUNTING OPTION RC3)
 NLIGHT* NLIGHT WIRED CONTROL (NOT AVAILABLE WITH MOUNTING OPTION RC3)
 LED DIMMING DRIVER IS STANDARD IN THIS PRODUCT
 *NLIGHT INTEGRATION REQUIRES A REMOTE POWER PACK (39NLAA & 39NLWA AS BELOW FOR NLIGHT).
 REFER TO NLIGHT GUIDE AND INSTALLATION SHEET FOR ALL REQUIREMENTS.

DV

DRIVER POSITION POSITION DE L'ALIMENTATION

RDP * RECESSED DRIVER
 * 3981C IS REQUIRED

CABLE CÂBLE

AC AIRCRAFT MOUNTING & CLEAR CABLE, FIELD ADJUSTABLE

AC

CABLE LENGTH LONGUEUR DE CÂBLE

60 60" AIRCRAFT CABLE (STD LENGTH)
 ** CUSTOM AIRCRAFT CABLE LENGTH (PLEASE SPECIFY)
 FOR OVERALL LENGTH, PLEASE CONTACT YOUR EUREKA REPRESENTATIVE.

MOUNTING MONTAGE

RC1 ROUND CANOPY ON JBOX FOR RECESSED DRIVERS 0.5" (2475C)
 RC2 ROUND SURFACE SCREWLESS CANOPY 1.87" (2475I)
 RC3 ROUND SURFACE SCREWLESS CANOPY 0.50" FOR REMOTE DRIVER BOX 12"X16" (2471C)
 * PAIR WITH ACCESSORY 3981GA

RC

MOUNTING CABLE OPTION OPTION DE MONTAGE DE CÂBLE

IF NO OPTION IS SELECTED, AN OFF-CENTERED ROUND CANOPY WITH STRAIGHT AIRCRAFT CABLES IS STANDARD

RCC CENTERED ROUND CANOPY - STRAIGHT AIRCRAFT CABLES

CANOPY FINISH FINI PAVILLON

BLKE BLACK FINE TEXTURE
 WHE WHITE FINE TEXTURE

POWER CORD FINISH FINI CÂBLE D'ALIMENTATION

BLK BLACK POWER CORD
 WH WHITE POWER CORD
 CLR CLEAR POWER CORD

RING FINISH FINI DE L'ANNEAU

BLKE BLACK FINE TEXTURE
 WHE WHITE FINE TEXTURE

ACCESSORY ACCESSOIRE

3981C JUNCTION BOX FOR RECESSED DRIVER OPTION SQ1 OR RC1
 3981GA REMOTE DRIVER BOX 12"X16" FOR MOUNTING RC3 FOR DC LOAD 90W
 39NLAA* NLIGHT AIR GEN 2 REMOTE CONTROLLER (NOT AVAILABLE WITH MOUNTING OPTION RC3)
 39NLWA* NLIGHT WIRED REMOTE CONTROLLER (NOT AVAILABLE WITH MOUNTING OPTION RC3)
 * FOR CHICAGO PLENUM INSTALLATION, PLEASE CONTACT YOUR EUREKA REPRESENTATIVE.



SPECIFICATION

ARENA STRAIGHT 8210

PROJECT PROJÉT
SPEC TYPE
NOTES

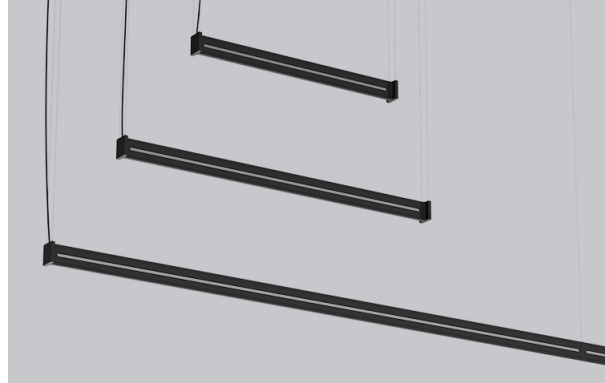

FINISH FINI

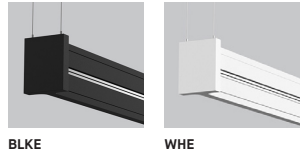

BLKE

WHE

FAMILY FAMILLE



ARENA - BEAM 8290

ARENA - GLOW 8291

ARENA - AIM 8292

ARENA - BALL 8295

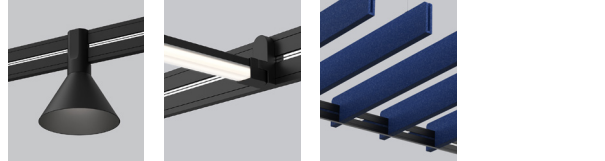

ARENA - CONE 8294

ARENA - SLICE SQ 8296

ARENA - ACOUSTIC 8298

MOUNTING CABLE OPTION OPTION DE MONTAGE DE CÂBLE

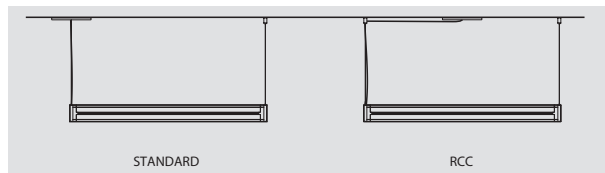

STANDARD

RCC

MOUNTING OPTION OPTION DE MONTAGE

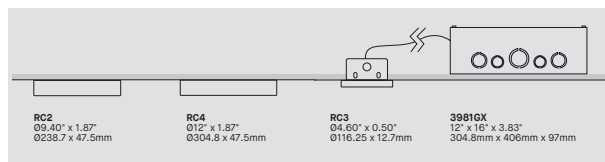

RC2
09.40" x 1.87"
0238.7 x 47.5mm

RC4
012" x 1.87"
0304.8 x 47.5mm

RC3
04.60" x 0.50"
0116.25 x 12.7mm

3981GX
12" x 10" x 3.83"
304.8mm x 406mm x 97mm

ORDERING SPECIFICATION SPÉCIFICATION DE COMMANDE

CODE

STANDARD MODEL MODÈLE STANDARD

8210-36	ARENA STRAIGHT 36"
8210-54	ARENA STRAIGHT 54"
8210-70	ARENA STRAIGHT 70" (2 SECTIONS CONNECTED WITH 1 JOINER)
8210-96	ARENA STRAIGHT 96"
8210-158	ARENA STRAIGHT 158" (3 SECTIONS CONNECTED WITH 2 JOINERS)
8210-190	ARENA STRAIGHT 190" (2 SECTIONS CONNECTED WITH 1 JOINER)
8210-285	ARENA STRAIGHT 285" (3 SECTIONS CONNECTED WITH 2 JOINERS)
8210-380	ARENA STRAIGHT 380" (4 SECTIONS CONNECTED WITH 3 JOINERS)

FOR CUSTOM SIZES, PLEASE CONTACT YOUR EUREKA REPRESENTATIVE.

DC LOAD PUISSANCE MAXIMALE DC

90W	1X 90 WATT (AVAILABLE FROM 36" TO 96")
180W	2X 90 WATT (AVAILABLE FROM 36" TO 190")
360W	4X 90 WATT (ONLY AVAILABLE FOR 285" TO 380")

ARENA STRAIGHT 8210	LIGHT SOURCES							ADAPTER TAA
	BEAM 8290	GLOW 8291	AIM 8292	SLICE-SQ 8296-36	SLICE-SQ 8296-54	BALL 8295	CONE 8294	
MAXIMUM DC LOAD 90W, 180W, 360W	8W DC	8W DC	8W DC	8W DC	11W DC	8W DC	11W DC	SEE SPEC SHEET
MAXIMUM TOTAL WEIGHT PER SECTION 25 LBS	0.62 LBS	0.70 LBS	0.61 LBS	2.22 LBS	3.50 LBS	0.48 LBS	0.88 LBS	

VOLTAGE VOLTAGE

120V	120 VOLT
277V	277 VOLT

CONTROL OPTIONS OPTION DE CONTRÔLE

DV	0-10V DIMMING (120V-277V)
NLTAIR2*	NLIGHT AIR CONTROL GEN2 (NOT AVAILABLE WITH MOUNTING OPTION RC3)
NLIGHT*	NLIGHT WIRED CONTROL (NOT AVAILABLE WITH MOUNTING OPTION RC3)

LED DIMMING DRIVER IS STANDARD IN THIS PRODUCT
*NLIGHT INTEGRATION REQUIRES A REMOTE POWER PACK (39NLAA & 39NLWA AS BELOW FOR NLIGHT). REFER TO NLIGHT GUIDE AND INSTALLATION SHEET FOR ALL REQUIREMENTS.

CABLE CÂBLE

AC	AIRCRAFT CABLE & POWER CORD, FIELD ADJUSTABLE
----	---

AC

CABLE LENGTH LONGUEUR DE CÂBLE

60	60" AIRCRAFT CABLE (STD LENGTH)
**	CUSTOM AIRCRAFT CABLE LENGTH (PLEASE SPECIFY)

FOR OVERALL LENGTH, PLEASE CONTACT YOUR EUREKA REPRESENTATIVE.

MOUNTING MONTAGE

RC2	ROUND SURFACE SCREWLESS CANOPY 9.4" FOR 90W ONLY (2475I)
RC3	ROUND SURFACE SCREWLESS CANOPY 4.6" FOR REMOTE DRIVER BOX 12"X16" (2471C) (PAIR WITH ACCESSORY 3981GA OR 3981GB)
RC4	ROUND SURFACE SCREWLESS CANOPY 12" FOR 180W OR 360W (2477I)

MOUNTING CABLE OPTION OPTION DE MONTAGE DE CÂBLE

RCC	FLOATING CANOPY - STRAIGHT AIRCRAFT CABLES IF NO OPTION IS SELECTED, A CANOPY AT END OF THE FIXTURE WITH AIRCRAFT CABLES IS STANDARD
-----	---

CANOPY & GRIPPERS FINISH FINI PAVILLON ET ATTACHES

BLKE	BLACK FINE TEXTURE
WHE	WHITE FINE TEXTURE

POWER CORD FINISH FINI CÂBLE D'ALIMENTATION

BLK	BLACK POWER CORD
WH	WHITE POWER CORD
CLR	CLEAR POWER CORD

FRAME FINISH FINI DU CADRE

BLKE	BLACK FINE TEXTURE
WHE	WHITE FINE TEXTURE

ACCESSORY ACCESSOIRE

3981GA	1 REMOTE DRIVER BOX 12"X16" FOR MOUNTING RC3 FOR DC LOAD 90W
3981GB	1 REMOTE DRIVER BOX 12"X16" FOR MOUNTING RC3 FOR DC LOAD 180W
3981GB2	2 REMOTE DRIVER BOXES 12"X16" FOR MOUNTING RC3 FOR DC LOAD 360W
39NLAA*	NLIGHT AIR GEN 2 REMOTE CONTROLLER (NOT AVAILABLE WITH MOUNTING OPTION RC3)
39NLWA*	NLIGHT WIRED REMOTE CONTROLLER (NOT AVAILABLE WITH MOUNTING OPTION RC3)

* FOR CHICAGO PLENUM INSTALLATION, PLEASE CONTACT YOUR EUREKA REPRESENTATIVE



SPECIFICATION

ARENA STRAIGHT 8210

CONFIGURATIONS

8210-36
ARENA STRAIGHT 36"

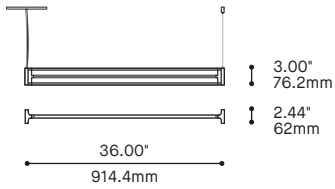

8210-54
ARENA STRAIGHT 54"

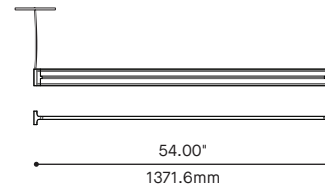

8210-70
ARENA STRAIGHT 70.4"

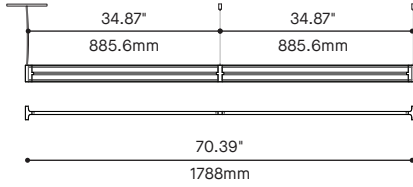

8210-96
ARENA STRAIGHT 96"

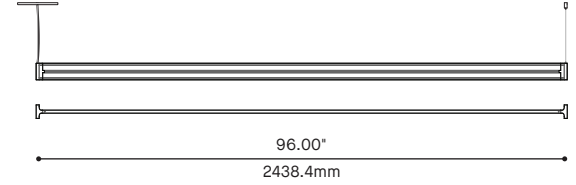

8210-158
ARENA STRAIGHT 158.78"

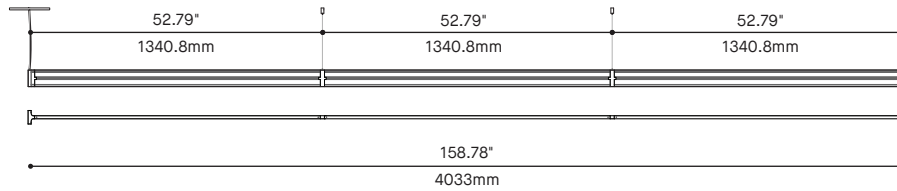

8210-190
ARENA STRAIGHT 190.39"

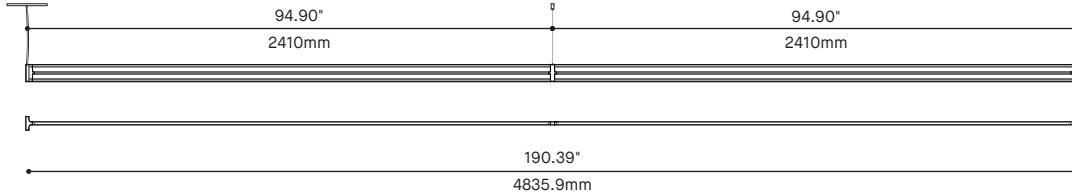

8210-284
ARENA STRAIGHT 284.7"

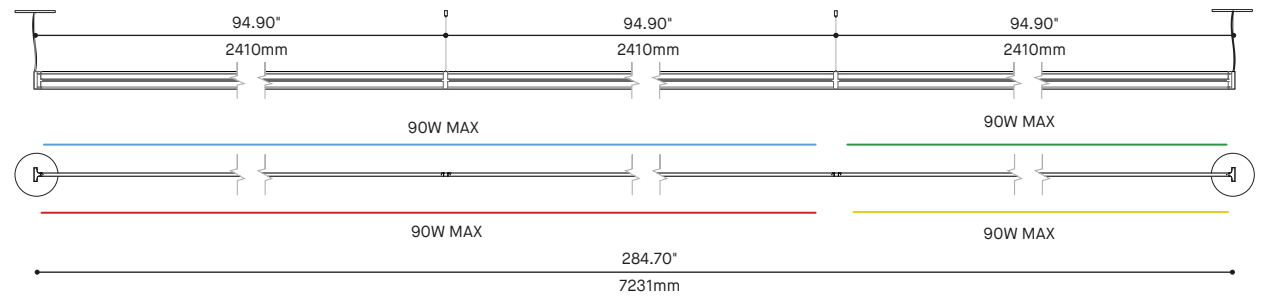

8210-380
ARENA STRAIGHT 379.6"

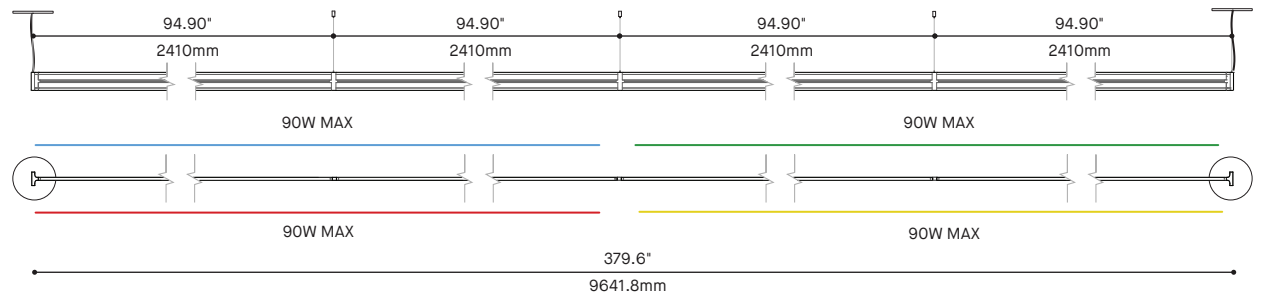

ARENA SQUARE & RECTANGLE 8220

PROJECT PROJÉT
SPEC TYPE
NOTES

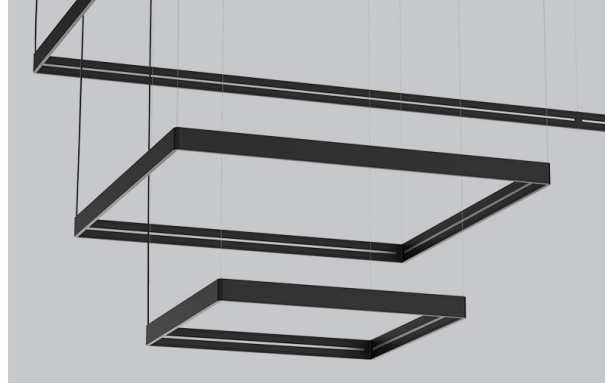

FINISH FINI

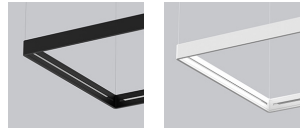

BLKE

WHE

FAMILY FAMILLE



ARENA - BEAM 8290

ARENA - GLOW 8291

ARENA - AIM 8292

ARENA - BALL 8295



ARENA - CONE 8294

ARENA - SLICE SQ 8296

ARENA - ACOUSTIC 8298

MOUNTING CABLE OPTION OPTION DE MONTAGE DE CÂBLE

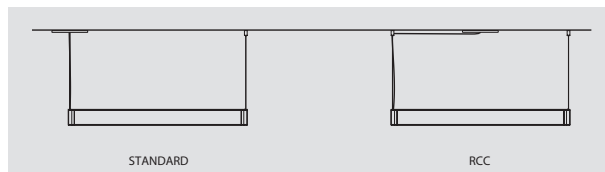

STANDARD

RCC

ORDERING SPECIFICATION SPÉCIFICATION DE COMMANDE

CODE

STANDARD MODEL MODÈLE STANDARD

8220-36X36	ARENA SQUARE 36X36"	8220-36X190	ARENA RECTANGLE 36X190"
8220-54X54	ARENA SQUARE 54X54"	8220-54X190	ARENA RECTANGLE 54X190"
8220-96X96	ARENA SQUARE 96X96"	8220-96X190	ARENA RECTANGLE 96X190"
8220-190X190	ARENA SQUARE 190X190"	8220-36X380	ARENA RECTANGLE 36X380"
8220-380X380	ARENA SQUARE 380X380"	8220-54X380	ARENA RECTANGLE 54X380"
8220-36X54	ARENA RECTANGLE 36X54"	8220-96X380	ARENA RECTANGLE 96X380"
8220-36X96	ARENA RECTANGLE 36X96"	8220-190X380	ARENA RECTANGLE 190X380"
8220-54X96	ARENA RECTANGLE 54X96"		

FOR CUSTOM SIZES, PLEASE CONTACT YOUR EUREKA REPRESENTATIVE.

DC LOAD PUISSANCE MAXIMALE DC

90W	1 CANOPY / 1 DRIVER OF 90W
180W	1 CANOPY / 2 DRIVERS OF 90W
360W	2 CANOPY / 4 DRIVERS OF 90W
540W	4 CANOPY / 6 DRIVERS OF 90W
720W	4 CANOPY / 8 DRIVERS OF 90W

8220	36"	54"	96"	190"	380"
36"	90W				
54"		180W	180W	360W	540W
96"					
190"					
380"					720W

ARENA SQUARE 8220
MAXIMUM DC LOAD SEE TABLE
MAXIMUM TOTAL WEIGHT PER SECTION 25 LBS

LIGHT SOURCES							
BEAM 8290	GLOW 8291	AIM 8292	SLICE-SQ 8296-36	SLICE-SQ 8296-54	BALL 8295	CONE 8294	ADAPTER TAA
8W DC	8W DC	8W DC	8W DC	11W DC	8W DC	11W DC	SEE SPEC SHEET
0.62 LBS	0.70 LBS	0.61 LBS	2.22 LBS	3.50 LBS	0.48 LBS	0.88 LBS	

VOLTAGE VOLTAGE

120V	120 VOLT
277V	277 VOLT

CONTROL OPTIONS OPTION DE CONTRÔLE

DV	0-10V DIMMING (120V-277V)
NLTAIR2*	NLIGHT AIR CONTROL GEN2 (NOT AVAILABLE WITH MOUNTING OPTION RC3)
NLIGHT*	NLIGHT WIRED CONTROL (NOT AVAILABLE WITH MOUNTING OPTION RC3)
	LED DIMMING DRIVER IS STANDARD IN THIS PRODUCT
	*NLIGHT INTEGRATION REQUIRES A REMOTE POWER PACK (39NLAA & 39NLWA AS BELOW FOR NLIGHT). REFER TO NLIGHT GUIDE AND INSTALLATION SHEET FOR ALL REQUIREMENTS.

CABLE CÂBLE

AC	AIRCRAFT CABLE & POWER CORD, FIELD ADJUSTABLE
----	---

AC

CABLE LENGTH LONGUEUR DE CÂBLE

60	60" AIRCRAFT CABLE (STD LENGTH)
**	CUSTOM AIRCRAFT CABLE LENGTH (PLEASE SPECIFY)
	FOR OVERALL LENGTH, PLEASE CONTACT YOUR EUREKA REPRESENTATIVE.

MOUNTING MONTAGE

RC2	ROUND SURFACE SCREWLESS CANOPY 9.4" FOR 90W ONLY (24751)
RC3	ROUND SURFACE SCREWLESS CANOPY 4.6" FOR REMOTE DRIVER BOX 12"X16" (2471C) (PAIR WITH ACCESSORY 3981GA OR 3981GB)
RC4	ROUND SURFACE SCREWLESS CANOPY 12" FOR 180W OR 360W (24771)

MOUNTING CABLE OPTION OPTION DE MONTAGE DE CÂBLE

RCC	FLOATING CANOPY - STRAIGHT AIRCRAFT CABLES
	IF NO OPTION IS SELECTED, A CANOPY AT CORNERS OF THE FIXTURE WITH AIRCRAFT CABLES IS STANDARD

CANOPY & GRIPPERS FINISH FINI PAVILLON ET ATTACHES

BLKE	BLACK FINE TEXTURE
WHE	WHITE FINE TEXTURE

POWER CORD FINISH FINI CÂBLE D'ALIMENTATION

BLK	BLACK POWER CORD
WH	WHITE POWER CORD
CLR	CLEAR POWER CORD

FRAME FINISH FINI DU CADRE

BLKE	BLACK FINE TEXTURE
WHE	WHITE FINE TEXTURE

MOUNTING OPTION OPTION DE MONTAGE

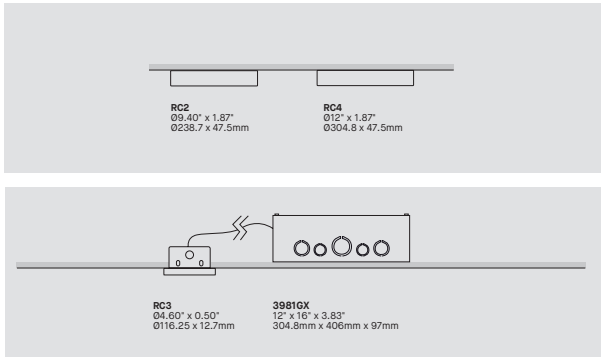

ACCESSORY ACCESSOIRE

- 3981GA** 1 REMOTE DRIVER BOX 12"X16" FOR MOUNTING RC3 FOR DC LOAD 90W
- 3981GB** 1 REMOTE DRIVER BOX 12"X16" FOR MOUNTING RC3 FOR DC LOAD 180W
- 3981GB2** 2 REMOTE DRIVER BOXES 12"X16" FOR MOUNTING RC3 FOR DC LOAD 360W
- 3981GB3** 3 REMOTE DRIVER BOXES 12"X16" FOR MOUNTING RC3 FOR DC LOAD 540W
- 3981GB4** 4 REMOTE DRIVER BOXES 12"X16" FOR MOUNTING RC3 FOR DC LOAD 720W
- 39NLAA*** NLIGHT AIR GEN 2 REMOTE CONTROLLER (NOT AVAILABLE WITH MOUNTING OPTION RC3)
- 39NLWA*** NLIGHT WIRED REMOTE CONTROLLER (NOT AVAILABLE WITH MOUNTING OPTION RC3)

* FOR CHICAGO PLENUM INSTALLATION, PLEASE CONTACT YOUR EUREKA REPRESENTATIVE

ARENA SQUARE 8220

CONFIGURATIONS

8220-36X36
ARENA SQUARE 36" x 36"

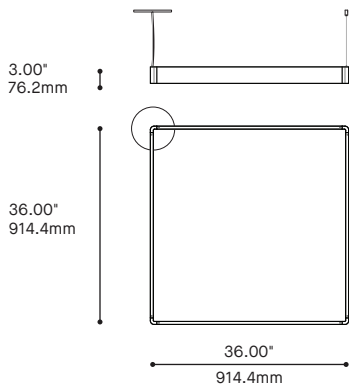

8220-54X54
ARENA SQUARE 54" x 54"

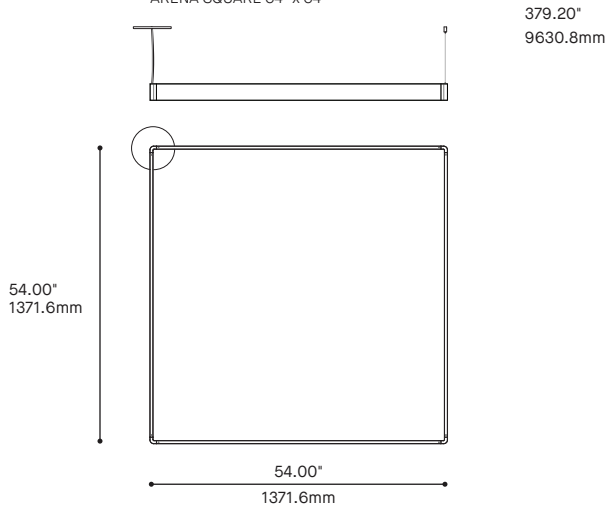

8220-96X96
ARENA SQUARE 96" x 96"

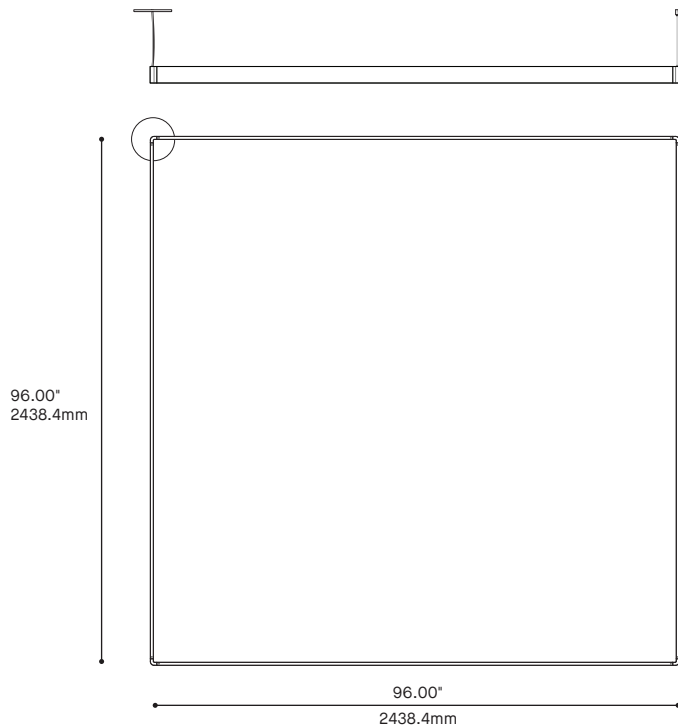

8220-380X380
ARENA SQUARE 380" x 380"

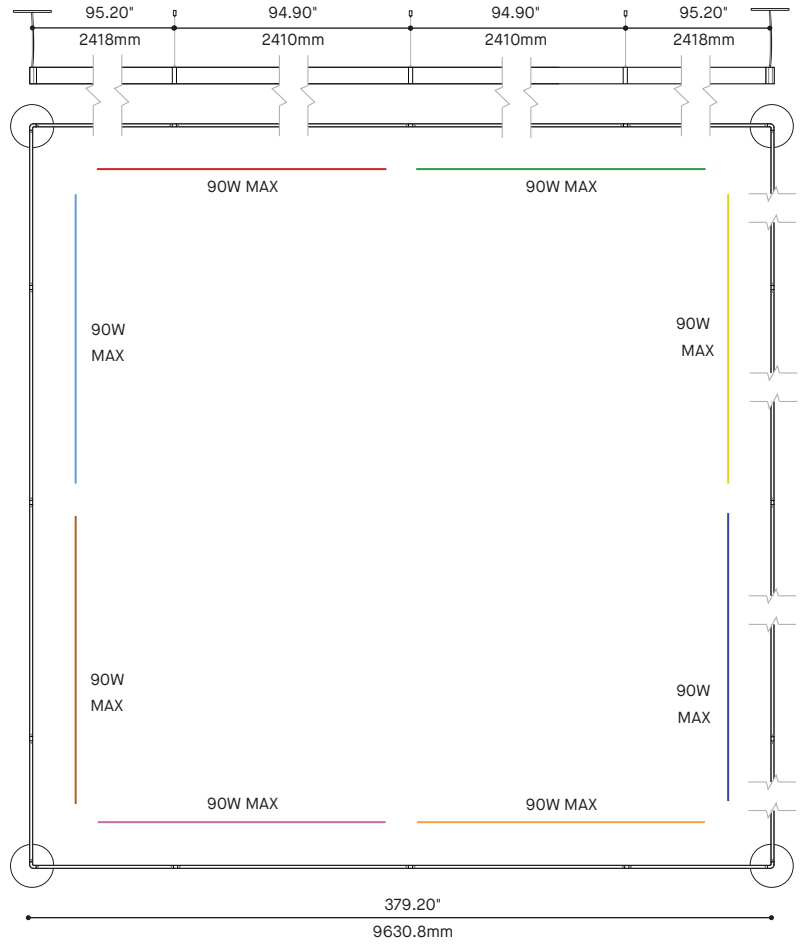

8220-190X190
ARENA SQUARE 190" x 190"

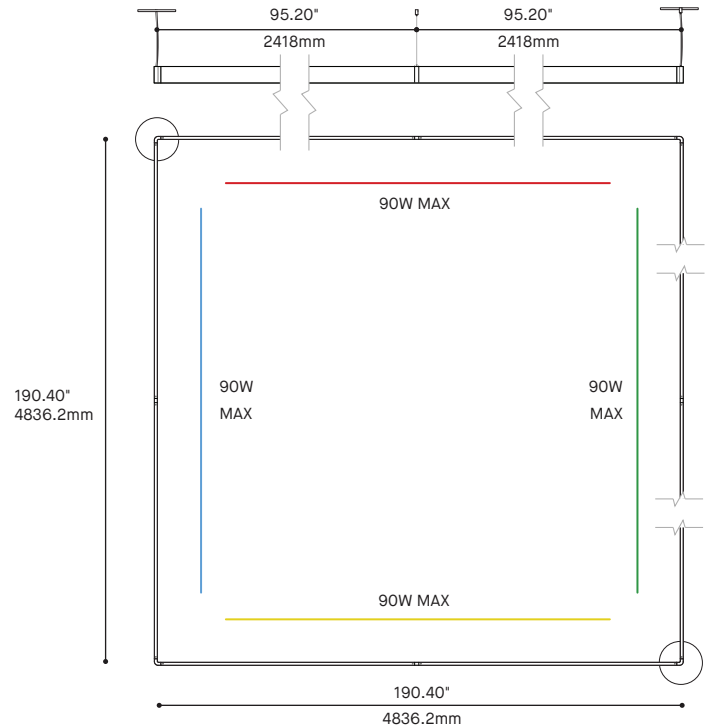

ARENA RECTANGLE 8220 1/2

CONFIGURATIONS

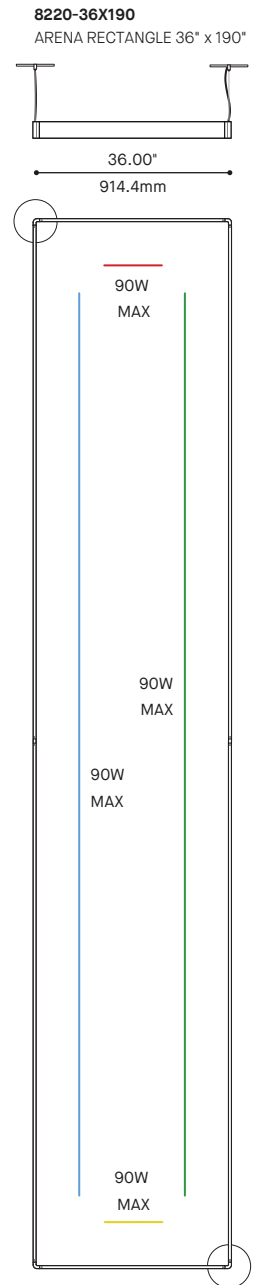
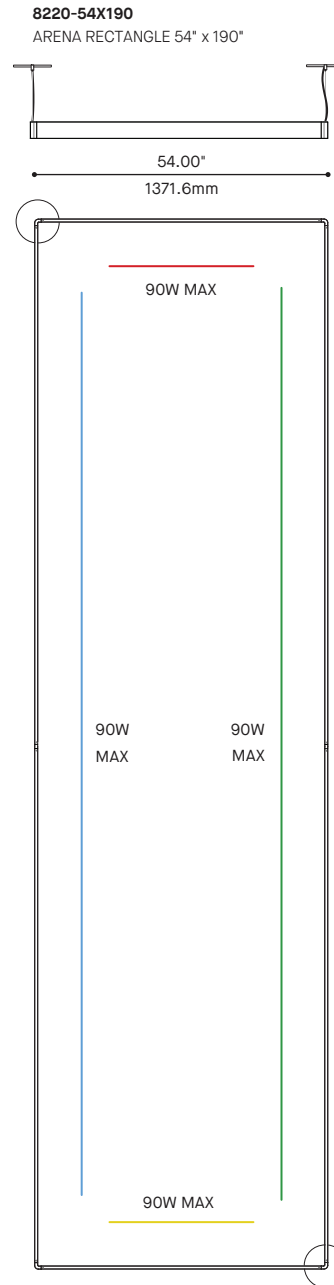
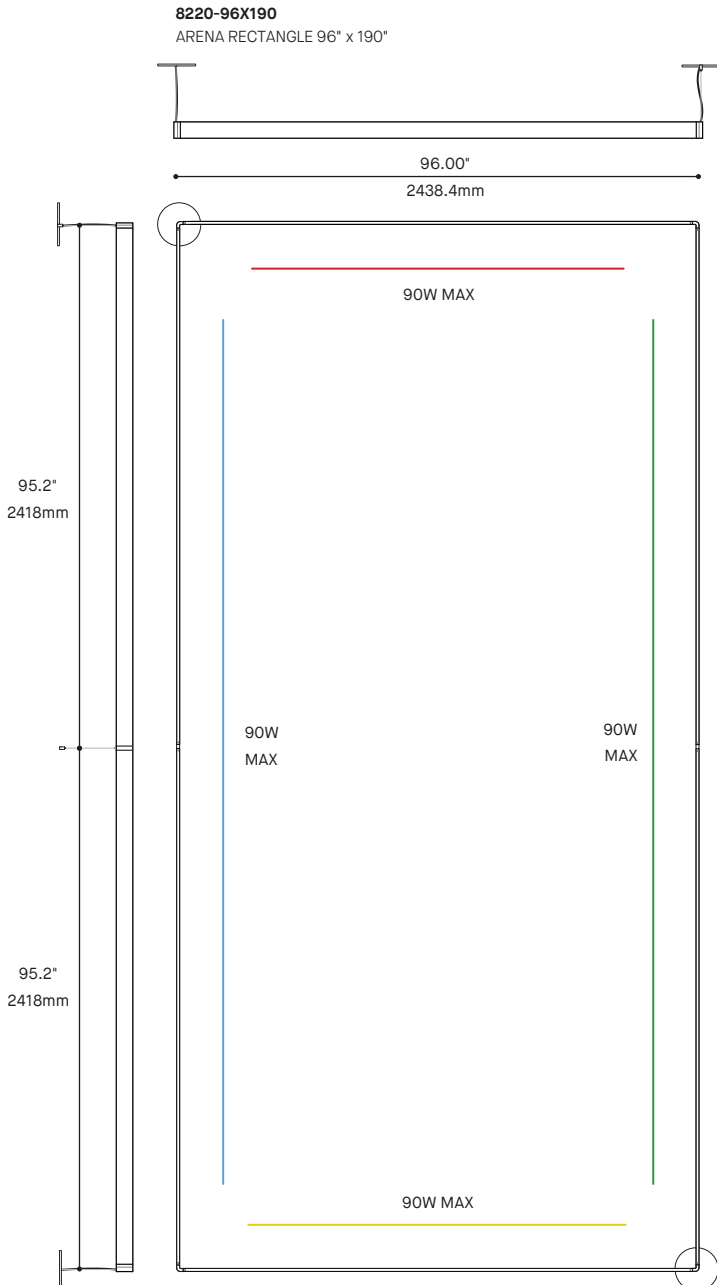
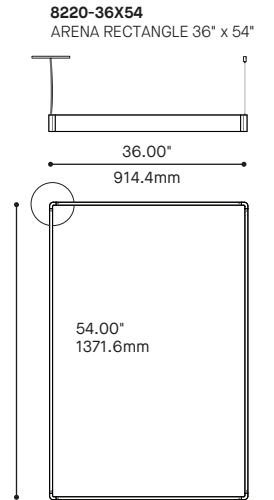
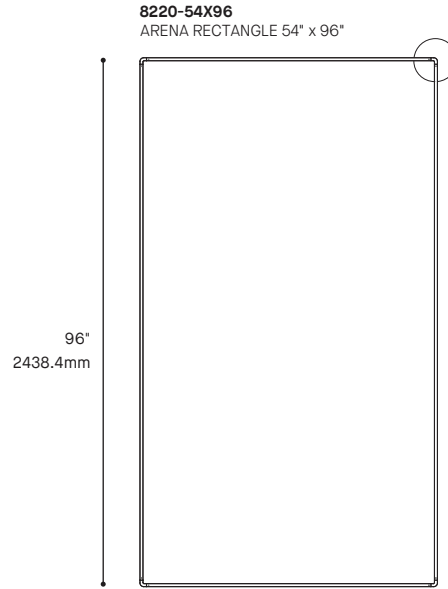
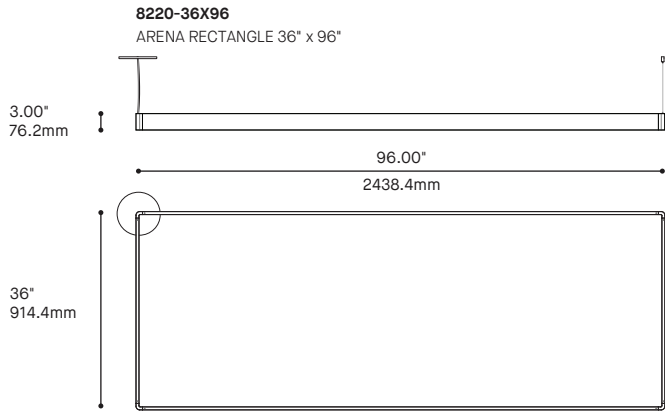

ARENA RECTANGLE 8220 2/2

CONFIGURATIONS

8220-96X380
ARENA SQUARE 96" x 380"

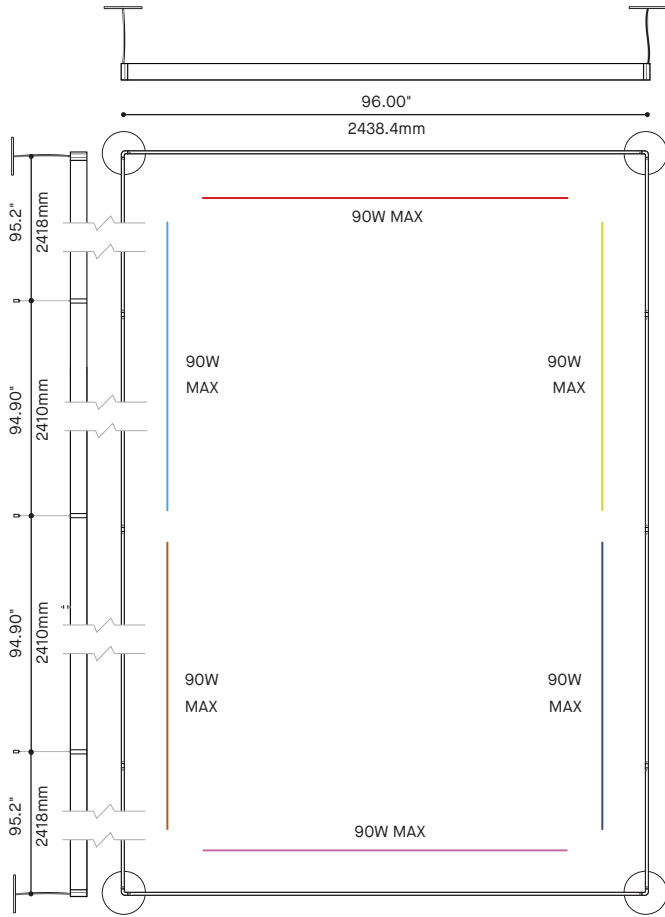

8220-54X380
ARENA RECTANGLE 54" x 380"

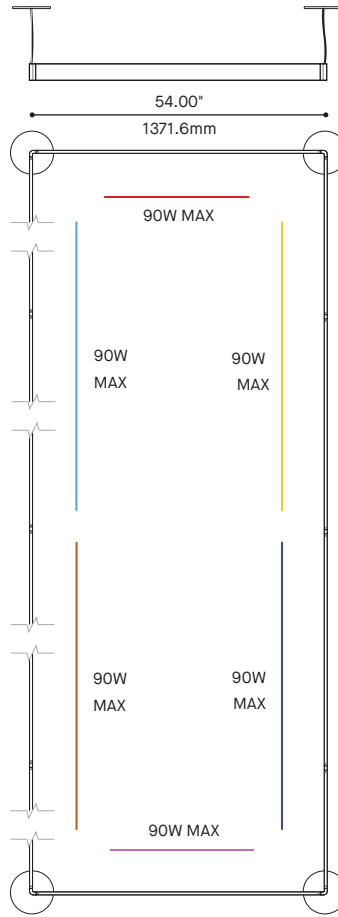

8220-36X380
ARENA RECTANGLE 36" x 380"

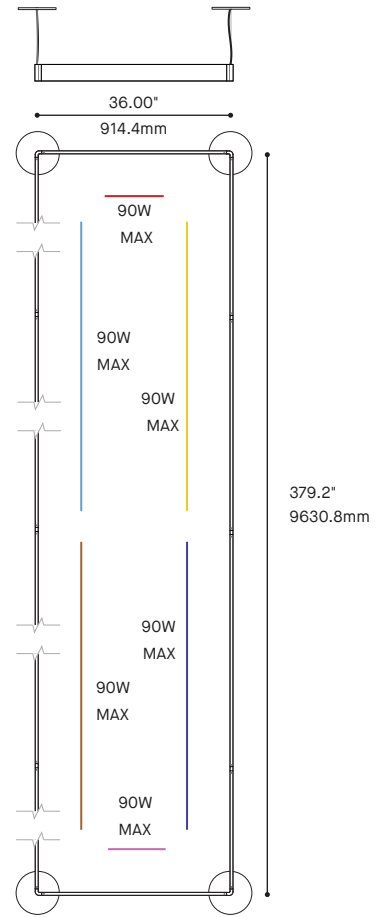

8220-190X380
ARENA RECTANGLE 190" x 380"

